

PROJETO ESTRUTURAL - MURO DE ARRIMO
ESCALA INDICADA

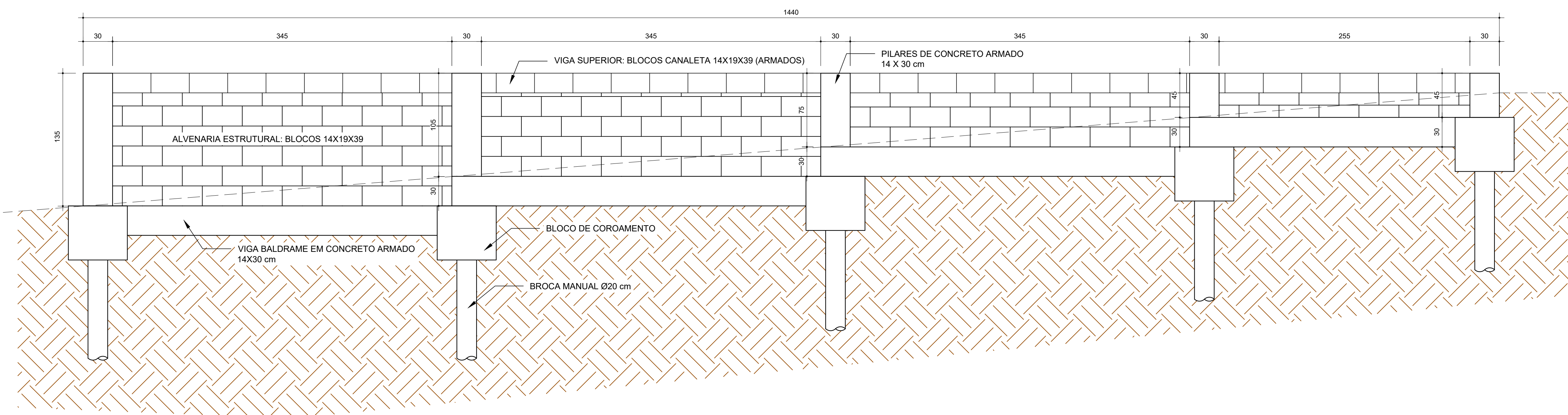

DETALHAMENTO DO MURO
ESCALA 1:25

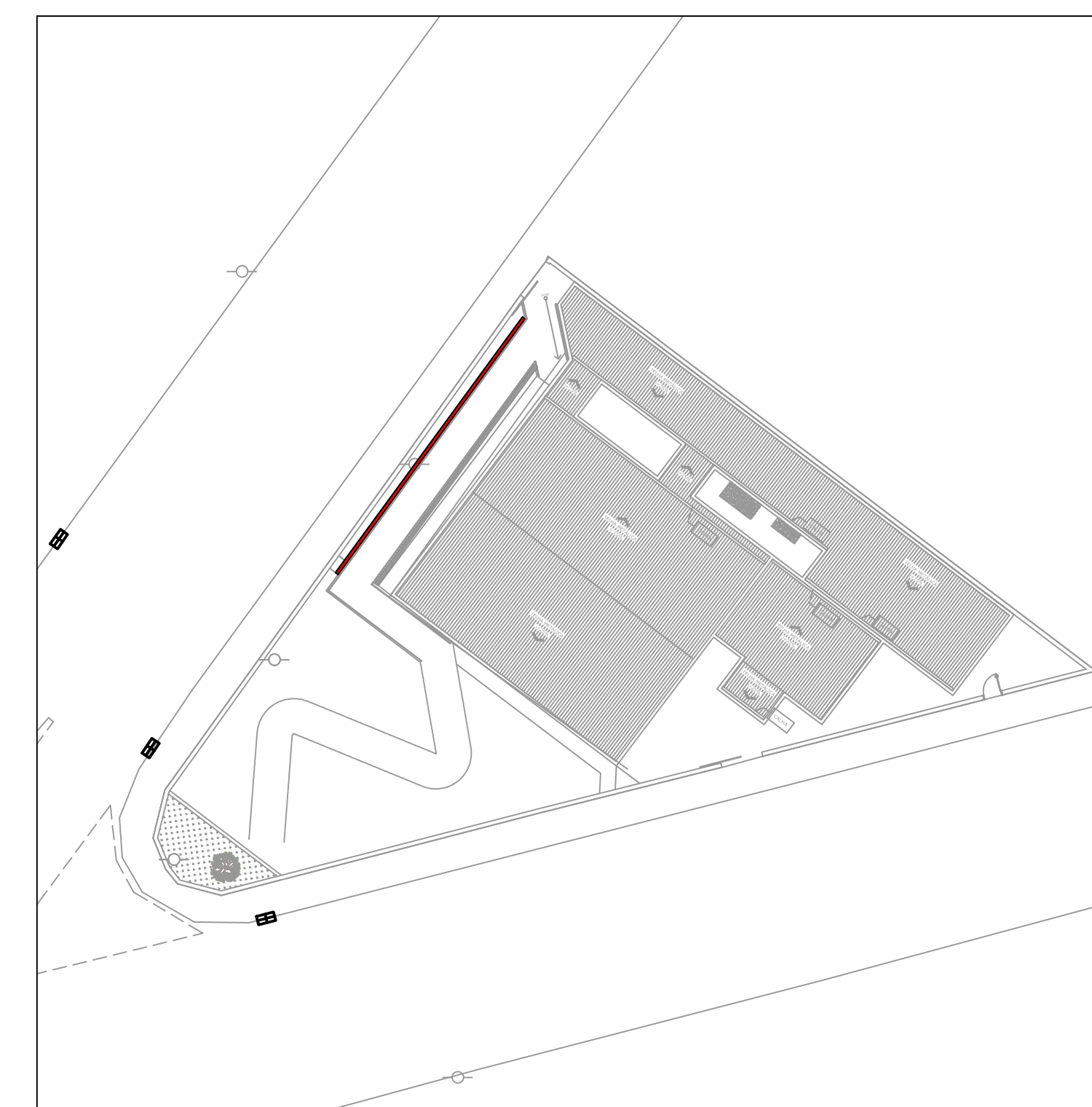

BLOCOS 1x20
PLANTA
ESCALA 1:50

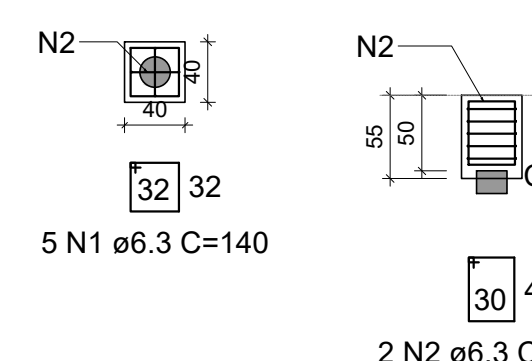

SEÇÃO LONGITUDINAL

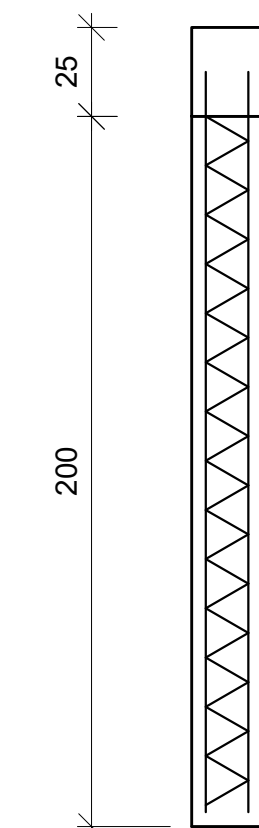

SEÇÃO TRANSVERSAL



DETALHE DAS BROCAS
SEM ESCALA

P1

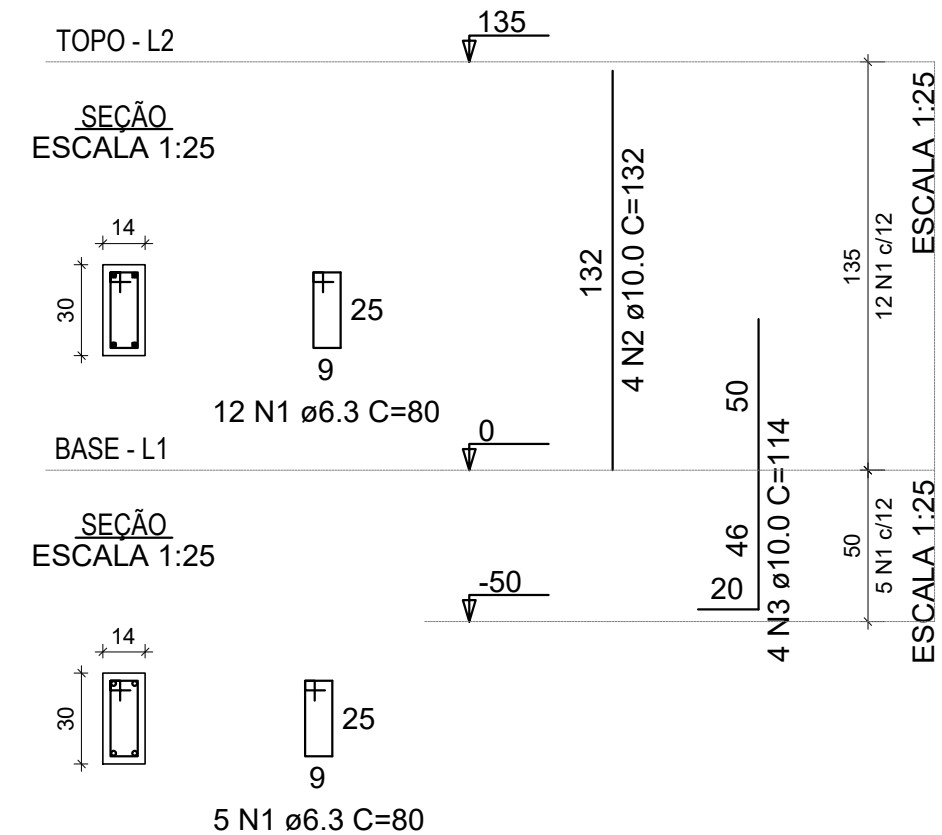

P2

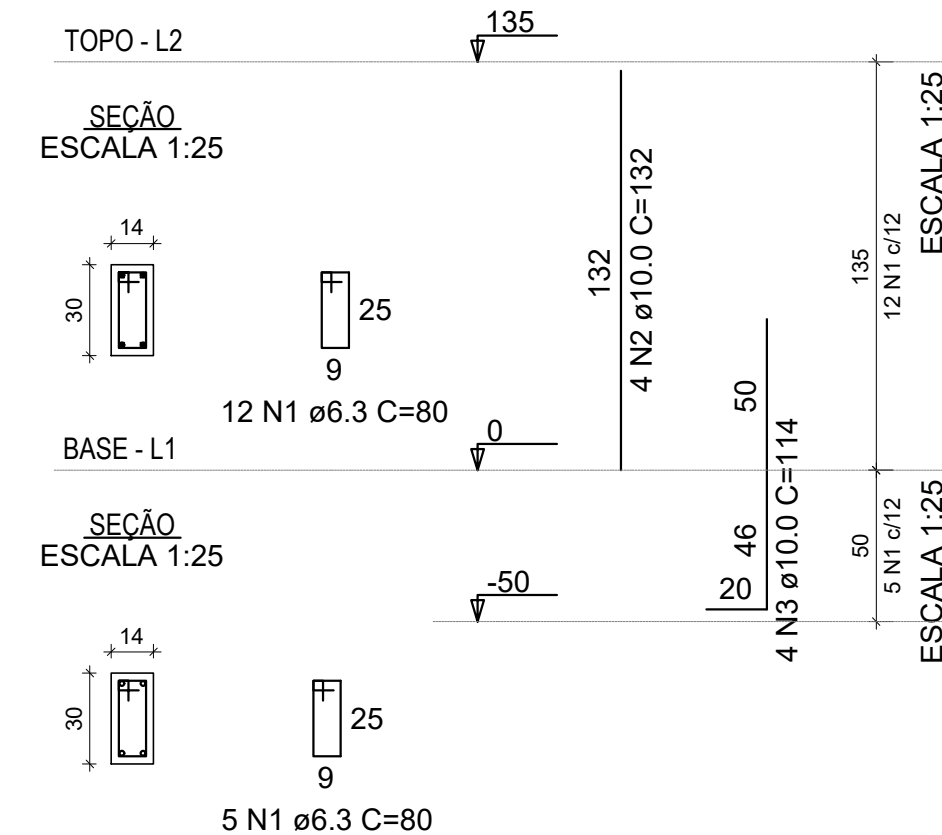

P3

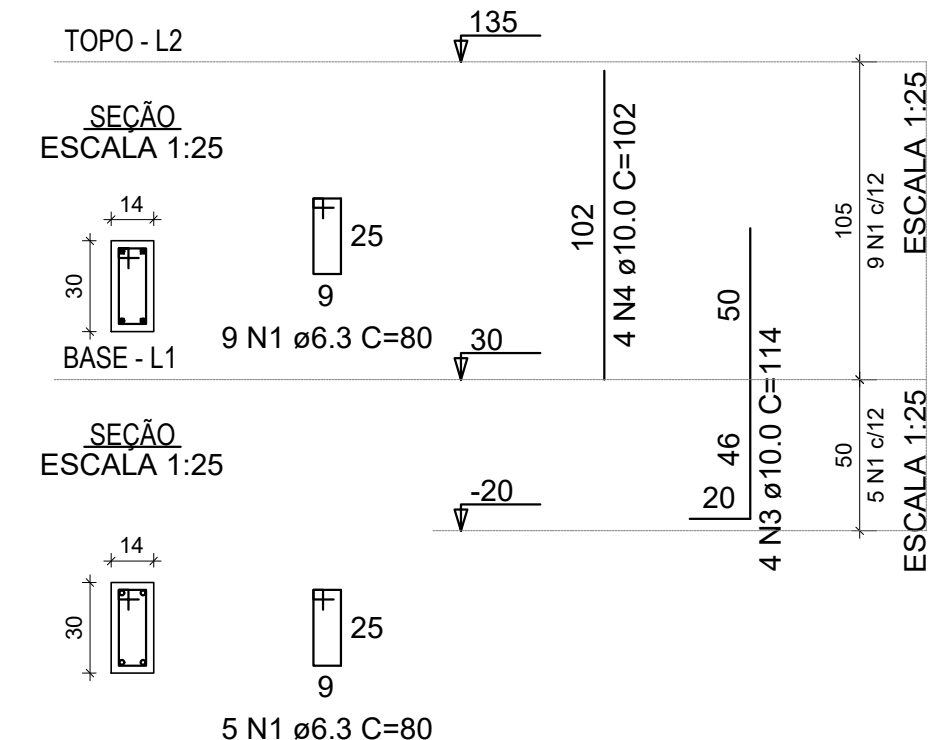

P4

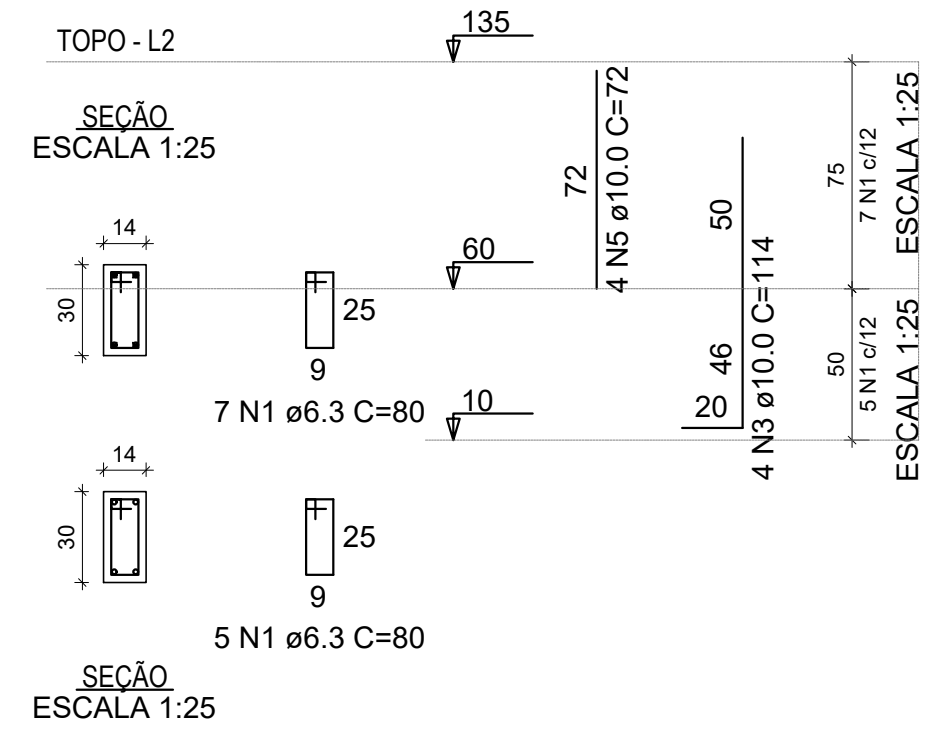

P5

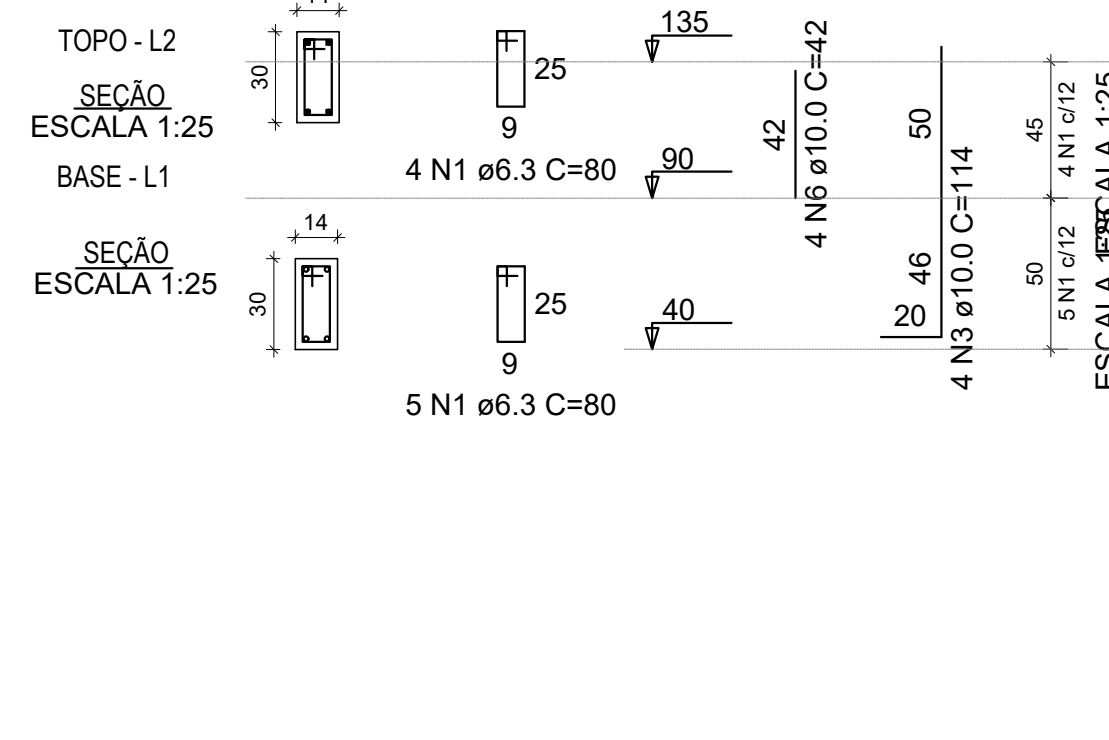

VB1

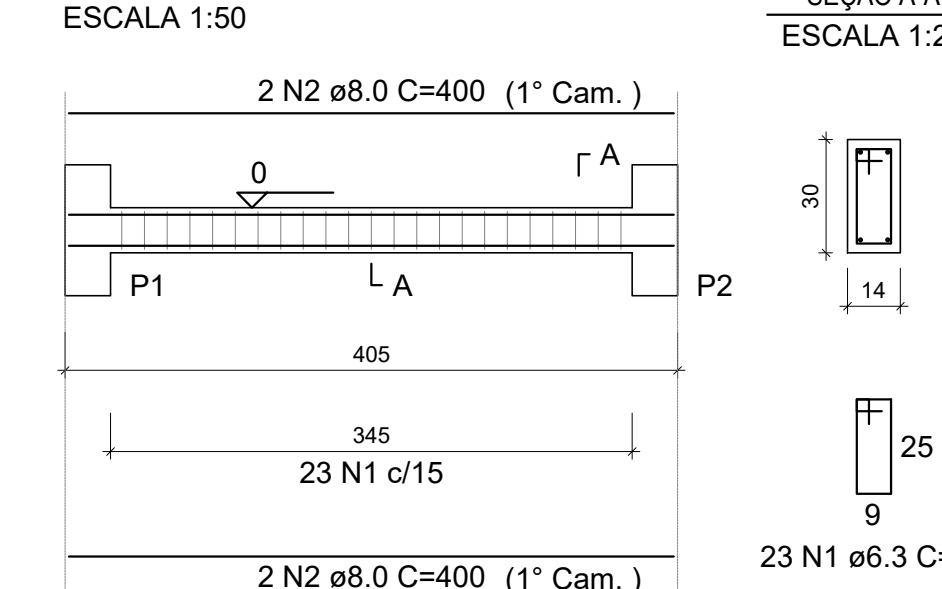

VB2

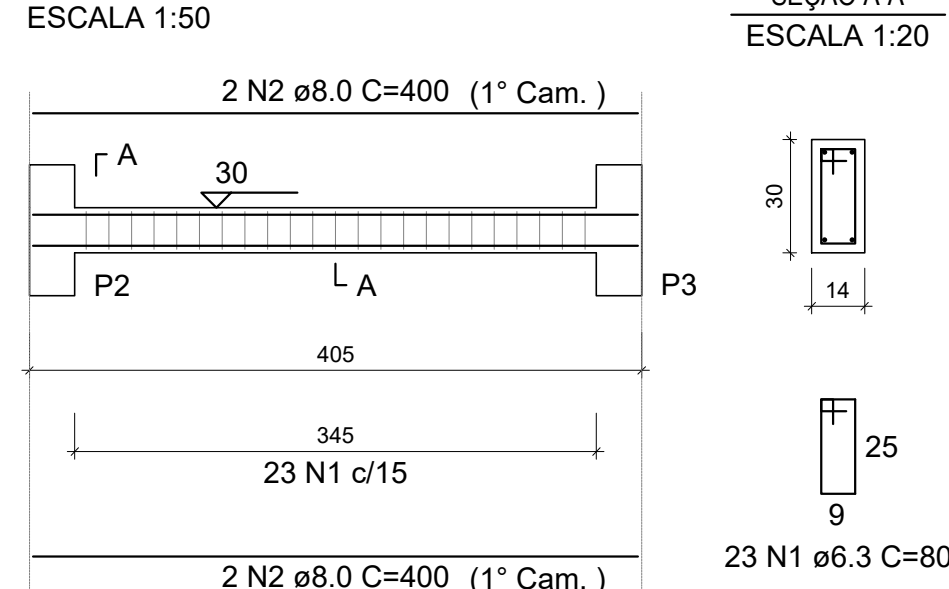

VB3

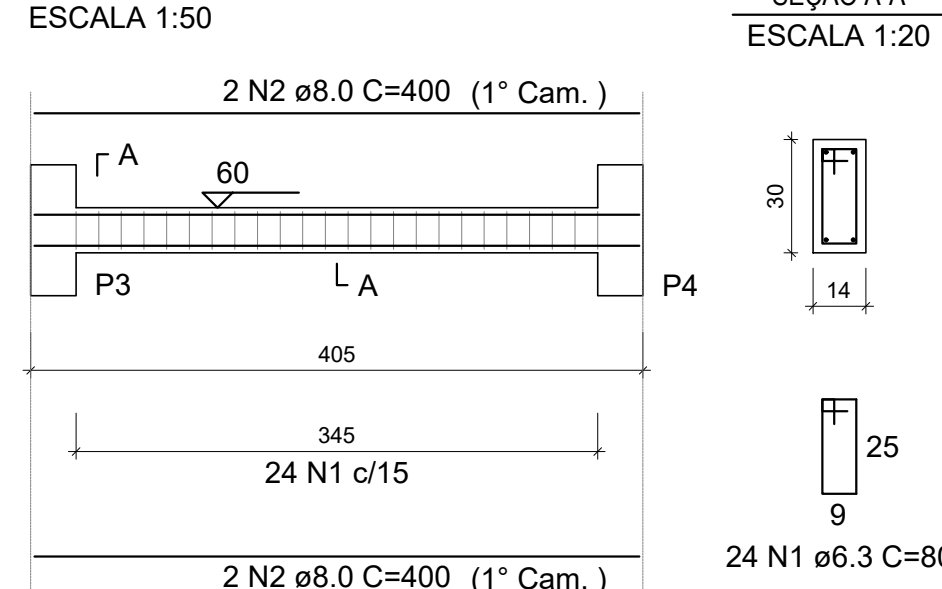

VB4

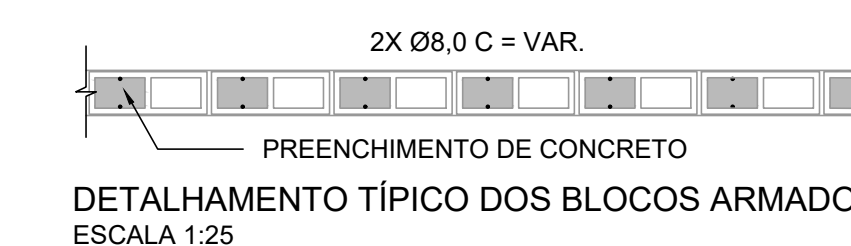
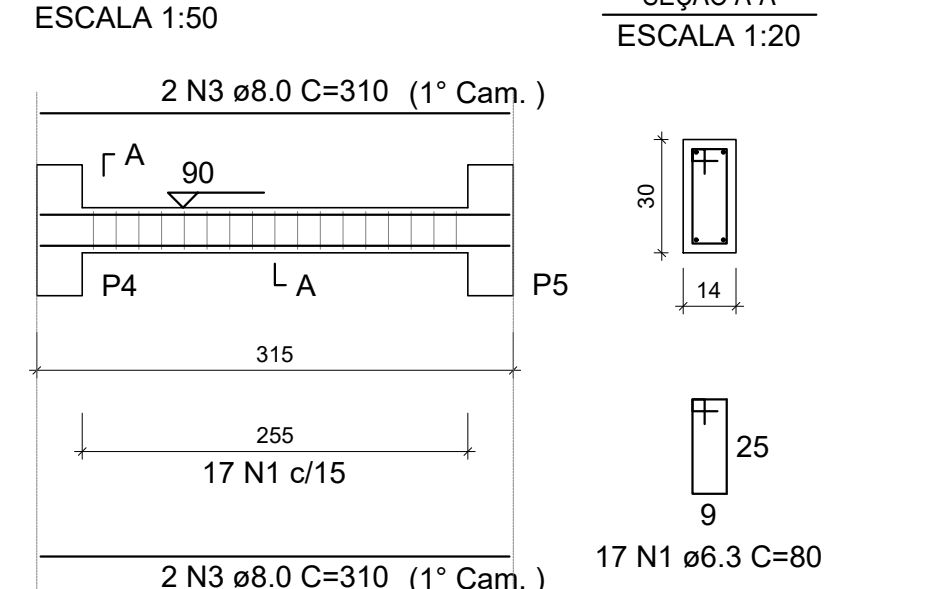

RESUMO DO AÇO

ALVENARIA ESTRUTURAL			
AÇO	DIAM (mm)	C.TOTAL (m)	PESO + 10% (kg)
CA50	8.0	46.2	20.1
PESO TOTAL (kg)			20.1

RELAÇÃO DO AÇO

BLOCOS					
AÇO	N	DIAM (mm)	QUANT	C.UNIT (cm)	C.TOTAL (cm)
CA50	1	6.3	25	140	3500
	2	6.3	10	156	1560

RESUMO DO AÇO

AÇO	DIAM (mm)	C.TOTAL (m)	QUANT + 10% (Barras)	PESO + 10% (kg)
CA50	6.3	50.6	5	13.6
PESO TOTAL (kg)				13.6

Volume de concreto (C-30) = 0.43 m³
Área de forma = 4.40 m²

RELAÇÃO DO AÇO

PILARES					
AÇO	N	DIAM (mm)	QUANT	C.UNIT (cm)	C.TOTAL (cm)
CA50	1	6.3	69	80	5520
	2	10.0	8	132	1056
	3	10.0	20	114	2280
	4	10.0	4	102	408
	5	10.0	4	72	288
	6	10.0	4	42	168

RESUMO DO AÇO

AÇO	DIAM (mm)	C.TOTAL (m)	QUANT + 10% (Barras)	PESO + 10% (kg)
CA50	6.3	55.2	6	14.9
CA50	10.0	42	4	28.5
PESO TOTAL (kg)				43.3

Volume de concreto (C-30) = 0.21 m³
Área de forma = 6.56 m²

RELAÇÃO DO AÇO

VIGAS BALDRAME					
AÇO	N	DIAM (mm)	QUANT	C.UNIT (cm)	C.TOTAL (cm)
CA50	1	6.3	87	80	6960
	2	8.0	12	400	4800
	3	8.0	4	310	1240

RESUMO DO AÇO

AÇO	DIAM (mm)	C.TOTAL (m)	QUANT + 10% (Barras)	PESO + 10% (kg)
CA50	6.3	69.6	7	18.7
CA50	8.0	60.4	6	26.2
PESO TOTAL (kg)				45

Volume de concreto (C-30) = 0.54 m³
Área de forma = 11.32 m²

REV. 01	10/05/22	CONFORME SOLICITAÇÕES DA SECRETARIA DE SAÚDE	DAC
REV. 00	21/01/22	EMISSÃO INICIAL	DAC
REVISÃO:	DATA:	DESCRIÇÃO:	RESP.:



Rua Miguel Vianna, n° 81, Sala 12
Bairro Morro Chic
CEP: 37500-080 - Itajubá / MG
Tel: (35) 3623-5720
www.dacengenharia.com.br

PROJETO: GERÊNCIA DE PROJETOS
PEDRO HENRIQUE JUSTINIANO ENQ CIVIL
COORDENAÇÃO DE PROJETOS
ALOSIO CAETANO FERREIRA CREA: MG-97.132/D
RESPONSÁVEL TÉCNICO
ENQ FLÁVIA CRISTINA BARBOSA CREA: MG-187.842/D
PROJETO: ENQ CIVIL WILLIAM BARADEL LARI
DESENHO: DAV VELOSO ALVES

EMPREENDIMENTO		DISCIPLINA
REFORMA DA UBS BELO HORIZONTE		ESTRUTURAL
ENDEREÇO	RUA MARIA DO C. BRUNHARA, 20 - B. BELO HORIZONTE POUSO ALEGRE - MINAS GERAIS	FASE DO PROJETO
ASSUNTO	MURO DE ARRIMO 1 DETALHAMENTO DOS ELEMENTOS ESTRUTURAIS LOCAÇÃO	EXECUTIVO
DATA INICIAL	ESCALA	FOLHA Nº
21/01/2022	INDICADA	01/02
REVISÃO	ARQUIVO	
R01	DAC--PMPA--UBH--PE--EST--R01.DWG	